

A distributed automation system does not contain any central automated control cabinets. Controls, sensors and actuators are designed for a high degree of protection (IP 65 / IP 67) and are installed directly in the field. In connection with these innovative installation concepts with distributed devices, users are demanding a standard connector family that is compatible with all interfaces. In response to these needs, the HARTING PushPull series has set the respective new appliance connection standard. PushPull technology is available for data, signal and power applications. Other interfaces accommodating USB or fiber optics (LC, SCRJ) supplement the universal range of the PushPull solutions. The integration of communication and power lines in a hybrid PushPull connector is a genuine trend-setting advance. In view of these strengths, the PushPull container has become the standard for current and future appliance interfaces. The German automotive industry, for example, has opted for the implementation of the PushPull connector family.

Application profile:

CONNECTION TYPE		ENVIRONMENT		APPLICATION						
Board to Board	Cable/Wire to Board	IP 20	IP 65 / IP 67	Data	Signal	Power	high performance			
							Data transfer rate	Shielding	Number of contacts, contact density	Voltage, working current
Cable termination			PCB termination			Application standard				
Han-Quick Lock®	IDC HARAX®	Crimp	THT	SMC	SMT					
Screw	Cage clamp	Axial screw	Press-in							
						Housing integration				
						Separate housing	Integrated housing			

1) Piercing contacts

CONTENTS	PAGE
Introduction PushPull termination technology	02.02
HARTING PushPull type acc. to IEC 61 076-3-106 variant 4	
HARTING PushPull – housing bulkhead mounting for device integration	02.04
HARTING PushPull RJ45	02.05
HARTING PushPull LC duplex	02.08
HARTING PushPull Hybride – Introduction	02.10
HARTING PushPull Hybride	02.11
HARTING PushPull Power – Introduction	02.14
HARTING PushPull Power, 4-poles, 48 V (12 A)	02.15
HARTING PushPull Power, 3-poles, 250 V (16 A)	02.17
HARTING PushPull Power – Tooling	02.18
Han® PushPull type acc. to IEC/PAS 61 076-3-117 variant 14	
Han® PushPull RJ45	02.19
Han® PushPull SCRJ	02.28
Han® PushPull Power 4/0, 5-poles, 230/400 V (16 A)	02.34
Han® PushPull Power 4/0 – Contacts and toolings	02.40
Han® PushPull Power L 4/0, 5-poles, 24 V (16 A)	02.41

The PushPull connector housing is a function container with degree of protection IP 65 / IP 67 and is available in two standardized housing sizes. These containers are equipped with standard RJ45, FOC or power contacts for operation at 5 x 16 A, depending on application requirements. The PushPull connector can be delivered either as plastic, or as metal variant, depending on the installation environment.

THE PushPull PRINCIPLE

PushPull connector applications combine two basic advantages:

1. Simple operation
2. Safe and vibration resistant sealed IP 65 / IP 67 connection.

The innovative PushPull lock mechanism dispenses with the need for a latching bracket. The connector can be inserted with one hand, minimum force and an audible click for safe operation. The connection can be removed again just as easily for service work.

COPPER, FOC AND POWER – IN THE SAME DESIGN

HARTING offers two series of the PushPull connector system, which differ in terms of their outer dimensions and module inserts.

Han® PushPull (IEC/PAS 61 076-3-117 VARIANT 14)

This series represents the standard PROFINET device interface for the IP 67 environment of the German automobile manufacturing industry.

The connector is available as metal and as plastic version. The RJ45 module for copper conductors and the SCRJ module for FOCs are available as data connectors. The RJ45 variant is realized by means of the RJ Industrial module equipped with HARAX® quick connection technology. The power module which is installed in the same container can be assembled on-site, either with crimp contacts or with innovative Quick Lock® technology in order to wire the distributed field devices to 230/400 V (16 A) power. This 5-pole connector enables the transfer of two



independent 24 V control circuits with functional ground, or the transfer of a three-phase voltage of 400 V (16A).

HARTING PushPull (IEC 61 076-3-106 VARIANT 4)

This extremely compact and space-saving series provides an Ethernet appliance connection with degree of protection IP 65 / IP 67 that requires no more installation space than a M12 connector. The RJ45 variant for copper conductors and the LC variant for FOCs are available as modules for data connectors. The RJ45 variant is realized by means of HARAX® quick connection technology as used with HARTING RJ Industrial®. The 4-pole module for 48 V (12 A) or the 3-pole module for 250 V (16 A) can be used to supply power to the distributed field devices.

HARTING PushPull HYBRID

The migration from Fieldbus to Ethernet within communication technology has simplified machine installation options. This

simplification is attained by combining the data and the 24 V power lines in a single hybrid cable with hybrid connector, in connection with the spatial requirements of an M12 connector.

The HARTING PushPull Hybrid offers trend-setting connection technology for this new method of machine installation.

The PushPull Hybrid reduces everything by half: the number of connection points and cables, and spatial requirements for the connection technology.

The PushPull Hybrid makes everything easier: machine installation, the wiring of connectors and safe insertion.

APPLIANCE INTEGRATION:

In order to support the implementation of appliances with degree of protection IP 65 / IP 67, HARTING offers panel feed-through devices with integrated couplings and female contact modules for direct mounting on PCBs.

PushPull

HARTING PushPull

ONE CONCEPT FOR DATA, SIGNAL AND POWER

The internationally standardized PushPull connector represents the latest generation of appliance connection technology with high degree of protection IP 65 / IP 67, easy insertion and snap-action engagement with audible click.

The PushPull housing family is designed for the integration of a wide range of contact inserts for data, signal and power lines.

INSTALLATION IN PLANTS

WITH Han® PushPull CONNECTORS:

- The standard for PROFINET communication
- One housing for the electrical and optical data transfer and for power supply
- Plastic or metal housing variants

INSTALLATION IN MACHINES

WITH HARTING PushPull HYBRID CONNECTORS:

- Combined data lines and appliance power supply up to 5 A in the same connector
- Compact size (comparable with M12)
- Straight and angled connector design, suitable for on-site assembly and overmolded

POWER SUPPLY TO DISTRIBUTED DEVICES

USING PushPull CONNECTORS:

- Variant 4: 48 V (12 A), 4-pole or 250 V (16 A), 3-pole
- Variant 14: 400 V (12 A) 5-pole, or 24 V (16 A) 5-pole
- Latest connection technology QuickLock® for on-site assembly without special auxiliary tools





HARTING PushPull Technology acc. to IEC 61076-3-106 variant 4 housing bulkhead mounting for device integration of RJ45- and Power-jacks

PushPull

Advantages

- PushPull housing bulkhead mounting with HARTING PushPull technology
- Compact, space-saving design for device integration of RJ45- or Power-pcb female

Housing bulkhead mounting EasyInstall

- for simple device integration round panel cut out

Housing bulkhead mounting Compact

- high packing density (spacing 27 x 21 mm)

Technical characteristics

Locking	PushPull Technology acc. to IEC 61 076-3-106 variant 4
Transmission rate	10/100/1000 Mbit/s
Shielding	fully shielded, 360° shielding contact
Mating cycles	min. 750
Degree of protection	IP 65 / IP 67
Temperature range	- 40 °C up to + 70 °C
Housing material	Plastic, black
Flammability acc. to UL 94	V 0
	UL approval (E102079)

Identification	Part No.	Drawing	Dimensions in mm
----------------	----------	---------	------------------

Components device side

Housing bulkhead mounting – EasyInstall with integrated seal board drillings for M3

without fixing clip

09 45 545 0030

with fixing clip

09 45 545 0031

Housing bulkhead mounting – Compact incl. flat seal board drillings for M2.5

without fixing clip

09 45 545 0023

with fixing clip

09 45 545 0021

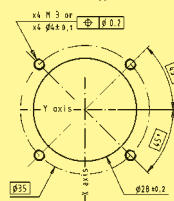
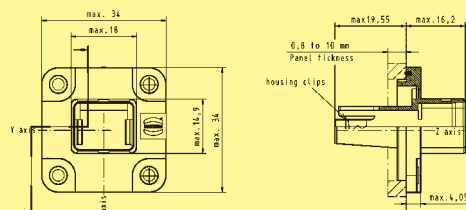

Panel cut out

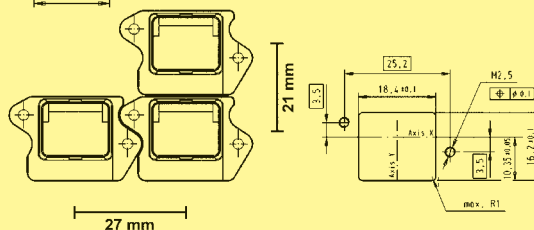
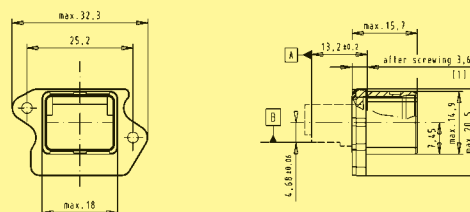



HARTING PushPull Technology acc. to IEC 61 076-3-106 variant 4
RJ45 jacks and accessories

Advantages

- HARTING PushPull technology
- Low-profile jacks for space-saving PCB integration
- Category of transmission Cat. 5

Technical characteristics

Locking	PushPull Tecgnology acc. to IEC 61 076-3-106 variant 4
Transmission rate	10/100/1000 Mbit/s
Shielding	fully shielded, 360° shielding contact
Mating cycles	min. 750
Degree of protection	IP 65 / IP 67
Temperature range	- 40 °C up to + 70 °C
Housing material	Plastic, black
Flammability acc. to UL 94	V 0
	UL approval (E102079)

Identification	Part No.	Drawing	Dimensions in mm pcb layout
Components device side			
RJ45 females Cat. 5			
Solder variant SMD, 90° angled	09 45 551 1100 ¹⁾ 09 45 551 1110 ²⁾		
Solder variant overmolded, 90° angled, with EMC contacts	09 45 551 1101 ¹⁾		
Solder variant overmolded, 90° angled	09 45 551 1102 ¹⁾		

¹⁾ Packaging: Blister à 120 pieces

²⁾ Packaging: Tape & Reel à 130 pieces

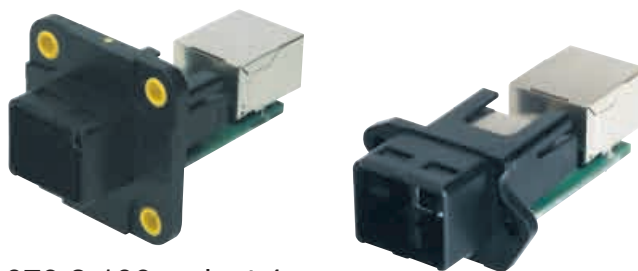

HARTING PushPull Technology acc. to IEC 61 076-3-106 variant 4
RJ45-panel feed-throughs and accessories

PushPull

Advantages

- Small, space-saving PushPull Interfaces in IP 65 / IP 67
- Easy handling of RJ45 patch cords in switch cabinets or sets
- Mounting to casings
- Category of transmission Cat. 5

Technical characteristics

Locking	PushPull Technology acc. to IEC 61 076-3-106 variant 4
Transmission rate	10/100/1000 Mbit/s
Shielding	fully shielded, 360° shielding contact
Mating cycles	min. 750
Degree of protection	IP 65 / IP 67
Temperature range	- 40 °C up to + 70 °C
Housing material	Plastic, black
Flammability acc. to UL 94	V 0
	UL approval (E102079)

Identification	Part No.	Drawing	Dimensions in mm
----------------	----------	---------	------------------

Panel feed-through set

incl. housing bulkhead mounting EasyInstall with integrated seal, 2 x RJ45-jacks mounting on PCB board drillings for M3

09 45 245 1130

incl. housing bulkhead mounting Compact, flat seal, 2 x RJ45-jacks mounting on PCB board drillings for M2,5

09 45 245 1102

Protection cover for housing bulkhead mounting

with cord IP 65 / IP 67 fixing ring for M2.5

Version with active locking

for screw M2.5
09 45 845 0004

for screw M3
09 45 845 0006

Version with passive locking

09 45 845 0009

IP 40 transport protection

for housing bulkhead mounting, rubber

09 45 845 0003

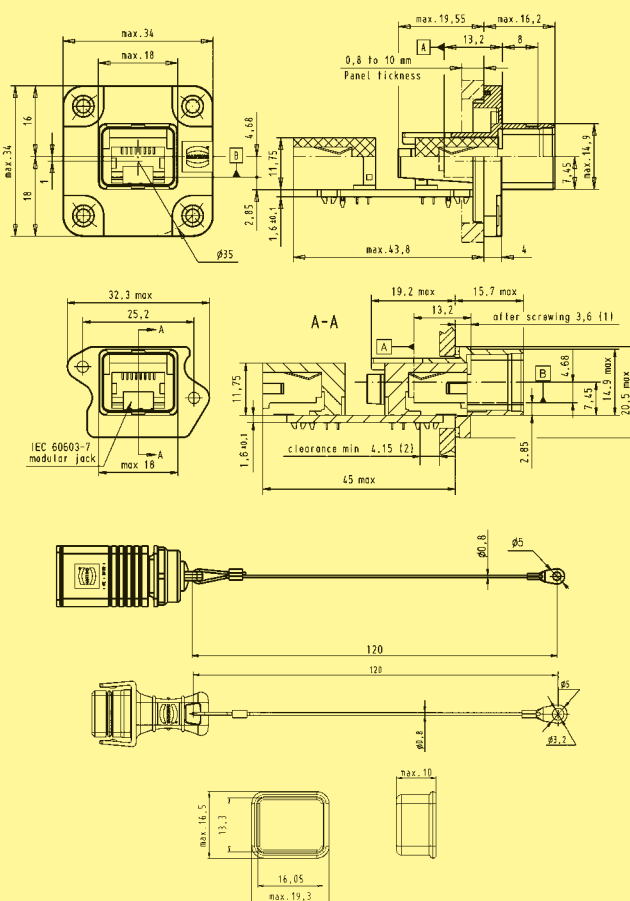



HARTING PushPull Technology acc. to IEC 61 076-3-106 variant 4
RJ45-connector

Advantages

- Ethernet connector based on RJ45
- Fully shielded, 360° shielding contact
- Field-assembly connector with IDC contacts (Cat. 5 versions) or piercing contacts (Cat.6 versions)

Technical characteristics

Locking	PushPull Technology acc. to IEC 61 076-3-106 variant 4
Degree of protection	IP 65 / IP 67
Mating face	RJ45 acc. to IEC 60 603-7
Cable diameter	5.8 ... 7.2 mm
Termination cross section	
Cat. 5	AWG 24/7 ... AWG 22/7 (stranded) AWG 23/1 ... AWG 22/1 (solid)
Cat. 6	AWG 24/7 ... AWG 27/7 (stranded)
Mating cycles	min. 750
Temperature range	-40 °C up to +70 °C
Housing material	Plastic, black
Flammability acc. to UL 94	V 0
	UL approval (E102079)

PushPull

Identification	Part No.	Drawing	Dimensions in mm
----------------	----------	---------	------------------

Connector, 4-poles
Cat. 5
incl. housing with RJ45 connector,
shielding and cable gland

09 45 145 1100

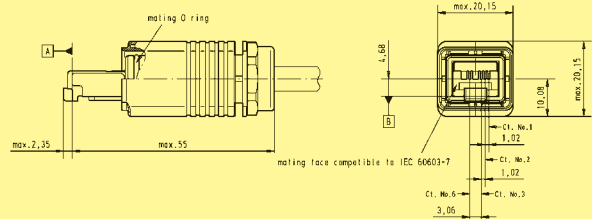

Connector, 8-poles
Cat. 6
incl. housing with RJ45 connector,
shielding and cable gland

Wire manager white

09 45 145 1500

Wire manager blue

09 45 145 1510

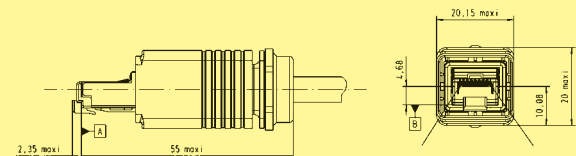

Reference note:
For cat. 6 patch cords it is recommended to use 1 connector with a white wire manager and one with an blue cable manager, in order to optimise the crosstalk between different signal pairs.

Tools

see page 01.08

System cables in different versions

see catalogue " Ethernet Network Solutions for Industry "



HARTING PushPull type acc. to IEC 61 076-3-106 variant 4
LC duplex panel feed-through and connector

PushPull

Advantages

- Optical PushPull connector based on LC with small form factor (requires 50 % compared to SC and ST)
- EasyInstall panel feed-through for simple device integration
- Optical module with inserts acc. to IEC 61 754-20
- One-piece LC body assures high mechanical stability
- A & B parts identification for Duplex according TIA 568 standard

Technical characteristics

Locking	PushPull Technology acc. to IEC 61 076-3-106 variant 4
Degree of protection	IP 65 / IP 67
Mating face	LC acc. to IEC 61 754-20
Cable diameter	5.8 ... 7.2 mm
Mating cycles	min. 200
Temperature range	-40 °C up to +70 °C
Housing material	Plastic, black
Flammability acc. to UL 94	V 0

Identification	Part No.	Drawing	Dimensions in mm
----------------	----------	---------	------------------

HARTING PushPull LC duplex

Cable side

Multimode GOF
Singlemode GOF

09 57 402 0500 000
09 57 402 0501 000

Device side EasyInstall

Multimode GOF
Singlemode GOF

09 57 441 0500 000
09 57 441 0501 000

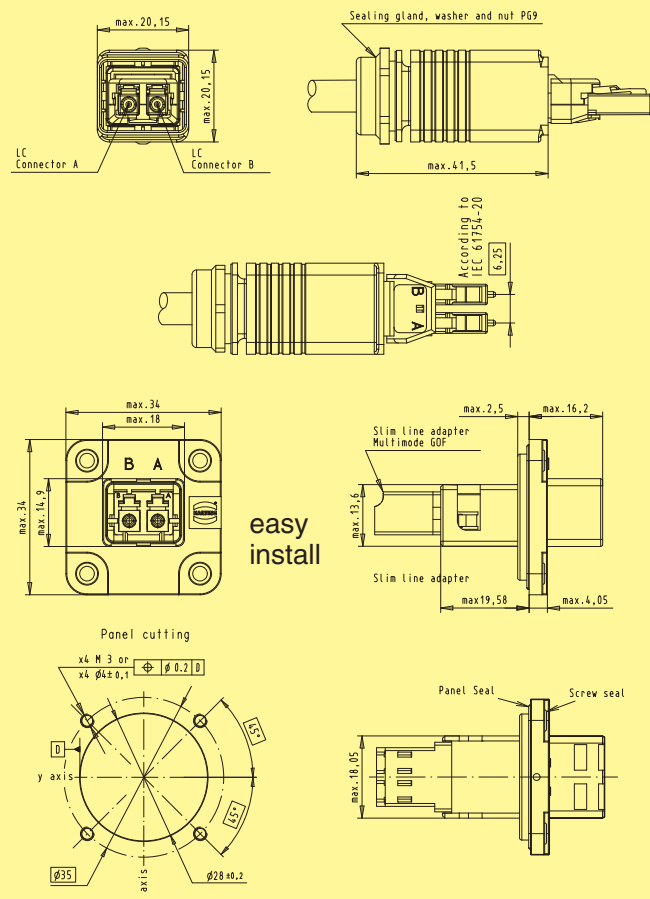



LC duplex IP 20 adapter for device integration

Advantages

- Small form factor requires 50 % (compared to SC and ST)
- Compact, space-saving design
- High packing density
- A & B parts identification according TIA 568 standard
- Complement adapter for IP 67 connector on device side

Technical characteristics

Degree of protection	IP 20
Mating interface	LC duplex with two fibres
Temperature range	-40 °C up to +70 °C

PushPull

Identification

Part No.

Drawing

Dimensions in mm

Device side

Adapter

Multimode GOF

09 57 400 0003 000

Singlemode GOF

09 57 400 0004 000

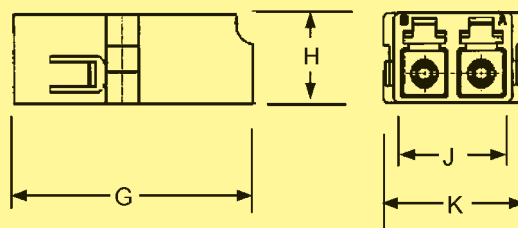

	min.	max.
G	26.60	26.80
H	9.35	9.45
J	12.80	12.90
K	15.24	15.34

Connector
LC duplex

Multimode GOF

09 57 400 0001 000

Singlemode GOF

09 57 400 0002 000

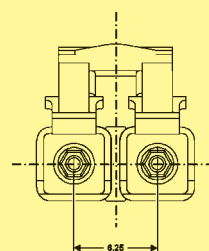
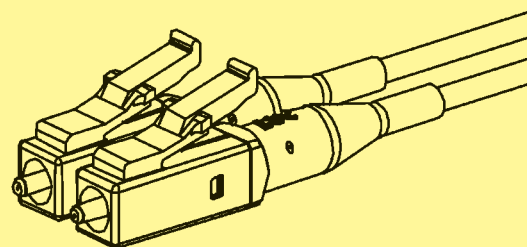



HARTING PushPull Hybrid
type acc. to IEC 61076-3-106 variant 4

Advantages

HARTING PushPull Hybrid

In the future all new machine generations will be equipped with Fast Ethernet, no matter if PROFINET, Ethernet/IP, Powerlink, Ethercat, Varan or other Ethernet profiles.

With the change of the communication technology also the possibility is offered of simplifying the machine installation and of introducing an innovative Hybrid installation concept. This simplification will unite by data and 24V (5A)-supply in a Hybrid cable, at least with the space requirement of a M12-connector.

For this new installation solution HARTING with the HARTING PushPull Hybrid offers the trend-setting installation technology.

Everything is halved: the number of pluggings, the number of cables and the space requirement for the connection technology. Everything becomes simpler: the installation, attaching and safe plugging.

The Hybrid connectors were developed particular under the criteria of simple attaching in the field and the particular safe data communication with the patented omega screen concept. As contacts D-Sub and HDD Sub contacts worked world-wide are used. This socket pin contact system ensures highest reliability and optimal shock and vibration stability.

With the optional available coding pins 6 different codings can be realized.

This connector is available in the variants straight or angled as well as for field assembling or overmolded.

Technical characteristics

Advantages

- Compact, space-saving design
- Very compact housing with high degree of protection
- Polarisation with nose
- Sixfold codable

Typical application areas

- Factory and building automation
- Industrial electronics
- Telecommunication and wireless networks
- Transportation
- Industrial monitoring and camera systems
- Lighting and display technology
- Access control systems

Recommended pin assignment

- Power contacts

Contact	Function	Conductor colour
1	V +	Red
2	Ground	Brown
3	V + (switched)	Yellow

- Data contacts

Contact	Signal	Function	Conductor colour
4	RD -	Receiver Data -	Blue
5	RD +	Receiver Data +	White
6	TD -	Transmission Data -	Orange
7	TD +	Transmission Data +	Yellow



Structure Hybrid cable
Data: 4x AWG26/7
Power: 3x AWG20/7



HARTING PushPull Hybrid, type acc. to IEC 61 076-3-106 variant 4 device side

Advantages

- Combined data- and power-supply up to 5A/32V included to one connector
- HARTING PushPull technology
- Compact design
- High packing density
- Sixfold codable
- Suitable for all Fast-Ethernet variants

Technical characteristics

Locking	PushPull Technology acc. to IEC 61 076-3-106 variant 4
Degree of protection	IP 65 / IP 67
Termination	Solder pins
Transmission performance	Category 5 / Class D up to 100 MHz acc. to ISO/IEC 11 801:2002, EN ISO 50 173-1
Transmission rate	10 / 100 Mbit/s
Number of contacts	Data: 4, shielded (Ethernet) Power: 3, (5A / 32V)
Housing material	Plastic, black
Flammability acc. to UL 94	V 0

Identification	Part No.	Drawing	Dimensions in mm
----------------	----------	---------	------------------

Components device side

Set straight

HARTING PushPull Hybrid housing bulkhead mounting and pcs female shielded, IP 65 / IP 67, black, 180° straight

09 45 245 1300

Set angled

HARTING PushPull Hybrid housing bulkhead mounting and pcs female shielded, IP 65 / IP 67, black, 90° angled

09 45 245 1310
(in preparation)

Female insert

PCB jack shielded 180° straight

09 45 545 1300

PCB jack shielded 90° angled

09 45 545 1305
(in preparation)

Housing bulkhead mounting

for female insert straight
for female insert angled

09 45 545 1320

09 45 545 1325
(in preparation)

Panel feed-through

1 x Hybrid female IP 65 / IP 67 on
1 x RJ45 female and 3 pcb clamps,
board drillings for M2.5

09 45 245 1320

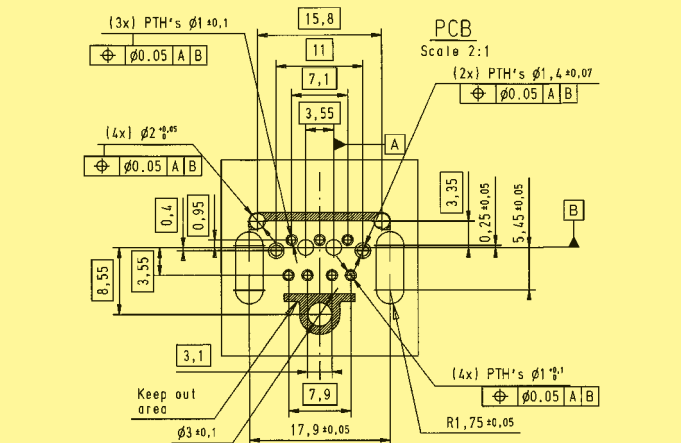
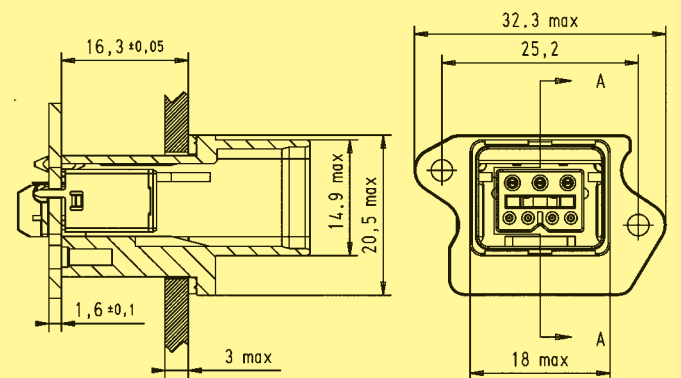



HARTING PushPull Hybrid, type acc. to IEC 61 076-3-106 variant 4
Hybrid connector

PushPull

Advantages

- Combined data- and power-supply up to 5A / 32V included to one connector
- HARTING PushPull technology
- Compact design
- High packing density
- Sixfold condable
- Suitable for all Fast-Ethernet variants

Technical characteristics

Locking	PushPull Technology acc. to IEC 61 076-3-106 variant 4
Degree of protection	IP 65 / IP 67
Termination	Crimp
Cable diameter	AWG 26 for Ethernet AWG 20 for Power
Transmission performance	Category 5 / Class D up to 100 MHz acc. to ISO/IEC 11 801:2002, EN ISO 50 173-1
Number of contacts	Data: 4, shielded (Ethernet) Power: 3, (5A / 32V)
Housing material	Plastic, black
Flammability acc. to UL 94	V 0

Identification	Part No.	Drawing	Dimensions in mm
----------------	----------	---------	------------------

Connector

HARTING PushPull Hybrid connector, IP 65/ 67, black, with cable gland and crimp contacts

straight

09 45 145 1300

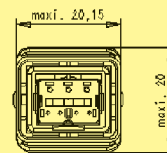
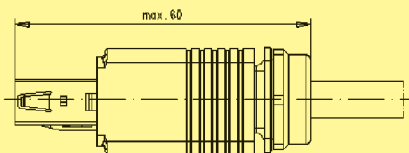

Accessories – Coding pin set

to avoid accidental incorrect mating a coding system is required. This coding pins are inserted without loss of contact.

09 45 845 1300

Tools

Crimping tool for data contacts

09 99 000 0596

Crimping tool for power contacts

09 99 000 0175



Insertion and removal tool

for data contacts

09 99 000 0513

for power contacts

09 99 000 0171





HARTING PushPull Hybrid, type acc. to IEC 61 076-3-106 variant 4 overmoulded Hybrid system cables

Advantages

- Combined data- and power-supply up to 5A / 32V included to one connector
- HARTING PushPull technology
- Robust design, suitable for industrial applications
- High packing density
- Sixfold codable
- Suitable for all Fast-Ethernet variants

Technical characteristics

Cable construction:	Twisted Pair shielded + 3 Power cables
Core structure	Data: 4x AWG 26/7 Power: 3x AWG 20/7
Transmission performance	Category 5 / Class D up to 100 MHz acc. to ISO/IEC 11 801:2002, EN ISO 50 173-1
Sheath material	FRNC
Cable-outer diameter	∅ (7.0 ±0.4) mm
Shielding	Shielding foil and shielding braid
Temperature range	- 40 up to + 80 °C
Colour	black

Identification Part No. Drawing Dimensions in mm

System cables 2x HARTING PushPull Hybrid

Length	0,5 m	09 47 616 1005
	1 m	09 47 616 1010
	2 m	09 47 616 1020
	3 m	09 47 616 1030
	5 m	09 47 616 1050
	10 m	09 47 616 1100
	20 m	09 47 616 1200

System cables 1x HARTING PushPull Hybrid, second side open

Length	0,5 m	09 47 610 0005
	1 m	09 47 610 0010
	2 m	09 47 610 0020
	3 m	09 47 610 0030
	5 m	09 47 610 0050
	10 m	09 47 610 0100
	20 m	09 47 610 0200

Hybrid cable

Ring	20 m	09 45 600 0331
Ring	50 m	09 45 600 0341
Ring	100 m	09 45 600 0301
Trommel	500 m	09 45 600 0321



Structure Hybrid cable

HARTING offers with the Han® PushPull S Power connector an universal solution for the power supply in compact and robust applications. It is in its element wherever small dimensions are combined with a high protection class.

The connector is available in a 4-pole 48 V and a 2-pole 250 V version. The power contacts can carry up to 12 resp. 16 A each (see deratings). In spite of this high current carrying capacity the connector gets by with minimal dimensions and fulfils the industrial requirements for clearances and creepage distances at the same time (pollution degree 3 and overvoltage category III).

Additionally the Han® PushPull S Power connector offers the protection class of IP 67 and 65. Beside numerous industrial use cases it is thereby suited for diverse applications in the fields of transportation and telecommunication.

The cable side of the Han® PushPull S Power is terminated with crimping technology. For the receptacle several solutions with different termination technologies are offered.

- Regulations**
- VDE 0110
 - DIN EN 61984

Advantages

- Minimum space requirements in spite of high current carrying capacity
- Very compact housing in a high protection class
- Protection against contact on plug AND receptacle side enables an easy and safe installation
- For low voltage (48 V) and for power supply (250 V) available
- Codeable without losing contacts
- Different termination technologies for individual device integration

Typical application areas

- Factory and building automation
- Industrial electronics
- Telecommunication and wireless networks
- Transportation
- Industrial monitoring and camera systems
- Lighting and display technology
- Access control systems

Current carrying capacity

The current carrying capacity is determined in tests which are conducted on the basis of the DIN IEC 60512-5-2. The current carrying capacity is limited by the thermal properties of materials which are used for inserts as well as by the insulating materials. These components have a limiting temperature which should not be exceeded.

Example of a current capacity curve

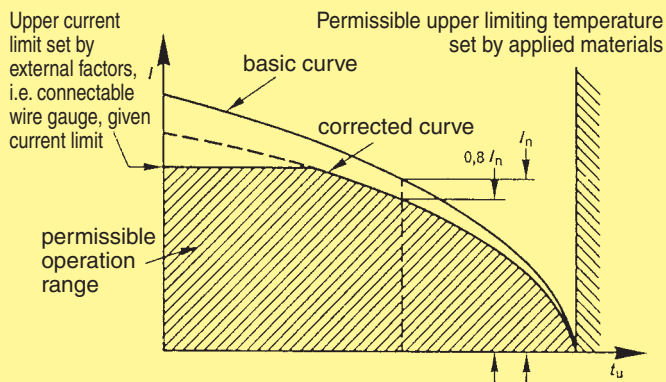

Derating-Diagramm for low voltage, 48V; 4x 12A

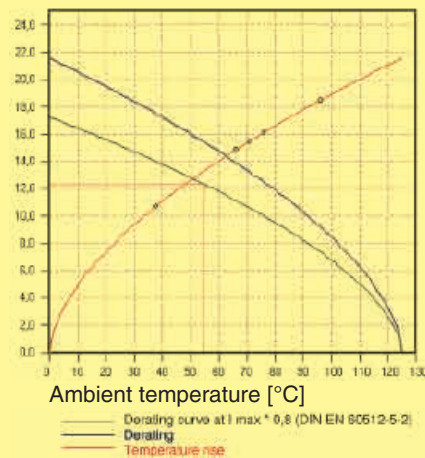

Derating-Diagramm for power supply, 250 V; 2x 16A

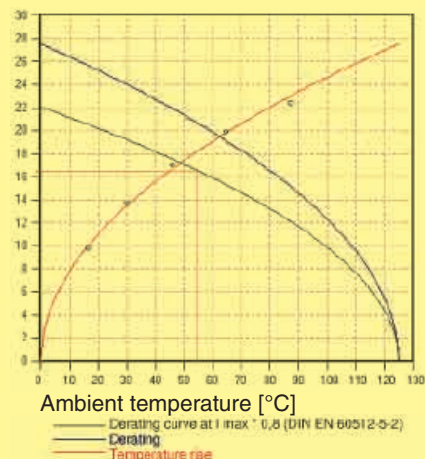



HARTING PushPull Power 4/0, type acc. to IEC 61076-3-106 variant 4 connector 4-poles 48V / 12A

PushPull

Advantages

- Power connectors for devices
- EasyInstall panel feed-through for simple device integration
- Compact, space-saving design
- Touch-proof according to IEC DIN EN 60 529
- Polarisation with nose
- Cable side: Male with crimp termination
- 4 different coding variants without loss of contact

Technical characteristics

Locking	PushPull Technology acc. to IEC 61 076-3-106 variant 4
Degree of protection	IP 65 / IP 67
Number of contacts	4
Electrical data acc. to EN 61 984	12 A 48 V 1.5 kV 3
Cable diameter	5.8 ... 7.2 mm
Termination	Crimp
Termination cross section	0.75 - 2.5 mm ² (AWG 20 - 12) stranded
Mating cycles	min. 750
Temperature range	-40 °C up to +70 °C
Housing material	Plastic, black
Flammability acc. to UL 94	V 0

Identification	Part No.	Drawing	Dimensions in mm
----------------	----------	---------	------------------

Connector set

incl. 4 turned crimp contacts (male), insulation, housing, cable gland

09 46 145 4400

Accessories – crimp contacts male

0.75 mm² (AWG 20 - 18)

09 46 500 0403

1.5 mm² (AWG 16 - 14)

09 46 500 0401

2.5 mm² (AWG 12)

09 46 500 0405

Accessories – Coding pin set

to avoid accidental incorrect mating a coding system is required. This coding pins are inserted without loss of contact.

09 46 840 0000

Accessories – protection cover IP 65 / IP 67 for connector with cord

09 45 845 0001

for device side with cord

09 45 845 0009

Accessories – transport protection IP40 for housing bulkhead mounting, rubber

09 45 845 0003

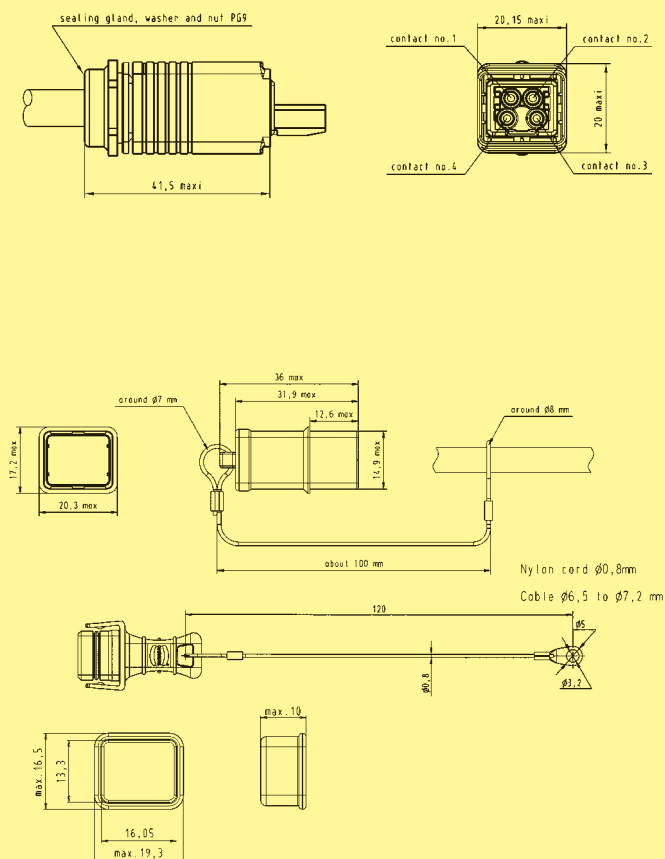

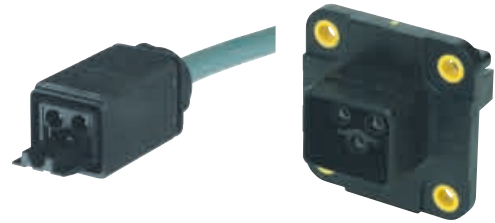

HARTING PushPull Power 2/0, type acc. to IEC 61 076-3-106 variant 4 panel feed-through and connector, 3-poles, 250 V / 16 A

Advantages

- Power connectors for devices
- EasyInstall panel feed-through for simple device integration
- Compact, space-saving design
- Touch-proof according to IEC DIN EN 60 529
- Polarisation with nose
- Cable side: Male with crimp termination
- Device side: female with crimp termination
- 4 different coding variants without loss of contact

Technical characteristics

Locking	PushPull Technology acc. to IEC 61 076-3-106 variant 4
Degree of protection	IP 65 / IP 67
Number of contacts	2 + PE
Electrical data acc. to EN 61 984	16 A 250 V 4 kV 3
Cable diameter	5.8 ... 7.2 mm
Termination	Crimp
Termination cross section	0.75 - 2.5 mm ² (AWG 20 - 12) stranded
Mating cycles	min. 750
Temperature range	-40 °C up to +70 °C
Housing material	Plastic, black
Flammability acc. to UL 94	V 0

Identification	Part No.	Drawing	Dimensions in mm
HARTING PushPull Power 2/0 Panel feed-through set incl. 3 turned crimp contacts (female), insulation (black), housing bulkhead mounting EasyInstall	09 46 245 3430		
Panel feed-through set incl. 3 turned female contacts, insulation (black), housing bulkhead mounting, with crimp termination	09 46 245 3410		
Connector set incl. 3 turned crimp contacts (male), insulation (black), housing, cable gland	09 46 145 3410		
Coding pin set to avoid accidental incorrect mating a coding system is required. This coding pins are inserted without loss of contact.	09 46 840 0000		
Protection cover IP 65 / 67 with cord	09 45 845 0001		

Identification	Part No.
Han® PushPull Power 8-indent crimping tool	09 46 800 0000
Locator HARTING PushPull Power contacts for crimping tool	09 46 800 0010
Crimping tool depth adjustment gauge	
Ø 1.02 mm	09 46 800 0002
Ø 1.15 mm	09 46 800 0003
Insertion tool	09 46 800 0099
Extraction tool	09 46 800 0098



For wire gauges
0.08 ... 4.0 mm²
(AWG 28 ... 12).

For the fine adjustment of the crimping depth of the Han® PushPull Power 8-indent crimping tool.

Wire	Gauge
0.25 mm ² ... 1.50 mm ²	Ø 1.02 mm
1.50 mm ² ... 2.50 mm ²	Ø 1.15 mm



For an easy insertion and extraction of the male and female crimp contacts into / out of the insulator body.

Crimp connection

A perfect crimp connection is gastight, therefore corrosion free and amounts to a cold weld of the parts being connected. For this reason, major features in achieving high quality crimp connections are the design of the contact crimping parts and of course the crimping tool itself. Wires to be connected must be carefully matched with the correct size of crimp contacts. If these basic requirements are met, users will be assured of highly reliable connections with low contact resistance and high resistance to corrosive attack.

The economic and technical advantages are:

- Constant contact resistance as a result of precisely repeated crimp connection quality
- Corrosion free connections as a result of cold weld action
- Pre-preparation of cable forms with crimp contacts fitted
- Optimum cost cable connection

Requirements for crimp connectors are laid down in DIN IEC 60352-2, Amend. 2, as illustrated in the table.

Pull out force of stranded wire

The main criterion to judge the quality of a crimp connection is the retention force achieved by the wire conductor in the terminal section of the contact. DIN IEC 60352, part 2, defines the extraction force in relation to the cross-section of the conductor. When fitted using HARTING crimping tools and subject to their utilization in an approved manner, our crimp connectors comply with the required extraction forces.

Crimping tools

Crimping tools (hand operated or automatic) are carefully designed to produce with high pressure forming parts a symmetrical connection of the crimping part of the contact and the wire being connected with the minimum increase in size at the connection point. The positioner automatically locates the crimp and wire at the correct point in the tool.

A ratchet in the tool performs 2 functions:

- ① It prevents insertion of the crimp into the tool for crimping before the jaws are fully open
- ② It prevents the tool being opened before the crimping action is completed

Identical, perfectly formed, connections can be produced using this crimping system.

Tensile strength of crimped connections

Conductor cross-section		Tensile strength
mm ²	AWG	N
0.08	28	11
0.12	26	15
0.14		18
0.22	24	28
0.25		32
0.32	22	40
0.5	20	60
0.75		85
0.82	18	90
1.0		108
1.3	16	135
1.5		150
2.1	14	200
2.5		230
3.3	12	275
4.0		310

Extract from DIN IEC 60352-2, Amend. 2, Table IV



Crimp-cross section
HARTING crimp profile



Han® PushPull, type acc. to IEC/PAS 61 076-3-117 variant 14
 Housing bulkhead mounting for device integration and RJ45 jacks

Features

- HARTING PushPull technology
- Compact design
- High packing density
- Device integration via RJ45 PCB connectors

Technical characteristics

Locking	PushPull technology acc. to IEC/PAS 61 076-3-117
Degree of protection	IP 65 / IP 67
Mating face	RJ45 acc. to IEC 60 603-7
Termination type	Female with solder termination
Mating cycles	min. 750
Temperature range	-40 °C ... +70 °C
Housing material	Plastic, black
Flammability acc. to UL 94	V 0

Identification

Part No.

Drawing

Dimensions in mm

Components device side

Housing bulkhead mounting plastic

09 35 002 0321

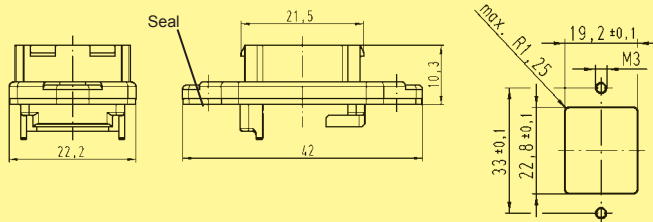

Dust protection cover IP 20 rubber (NBR)

09 35 002 5401

RJ45 female Solder variant, 90° angled

09 35 002 2101

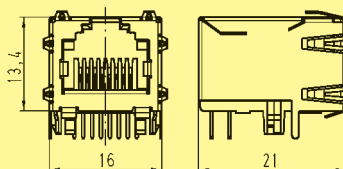

Solder variant, 180° straight

09 35 002 2102

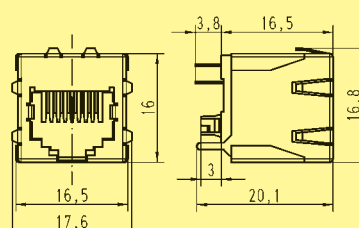

PCB layout

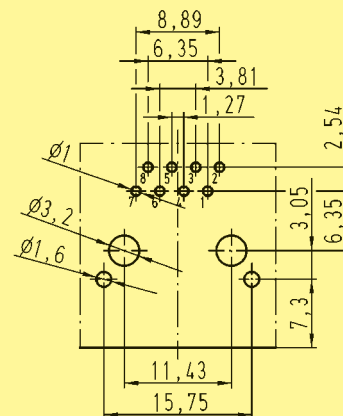



Han® PushPull, type acc. to IEC/PAS 61 076-3-117 variant 14
RJ45 panel feed through

PushPull

Features

- HARTING PushPull technology
- Compact design
- High packing density
- Device integration via RJ45 PCB connectors

Technical characteristics

Locking	PushPull technology acc. to IEC/PAS 61 076-3-117
Degree of protection	IP 65 / IP 67
Mating face	RJ45 acc. to IEC 60 603-7
Termination type	Female with solder termination
Mating cycles	min. 750
Temperature range	-40 °C ... +70 °C
Housing material	Plastic, black
Flammability acc. to UL 94	V 0

Identification

Part No.

Drawing

Dimensions in mm

Han® PushPull RJ45

Panel feed through including housing and printed board with 2 x RJ45 jack horizontally mounted

09 35 221 0331

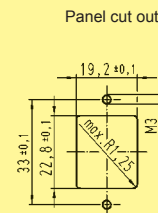
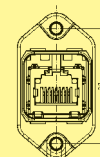
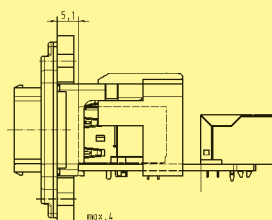

Panel feed through including housing and printed board with RJ45 jack and SEK board

09 35 222 0331

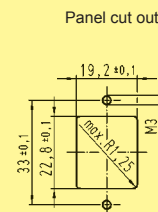
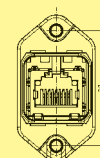
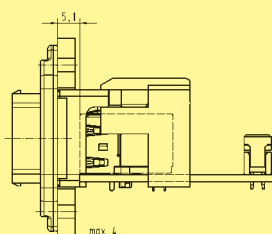

Panel feed through including housing and printed board with RJ45 jack and RJ45 jack vertically mounted in the IP20 range

09 35 223 0331

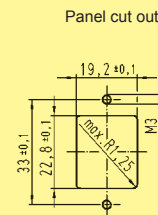
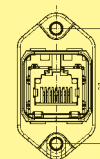
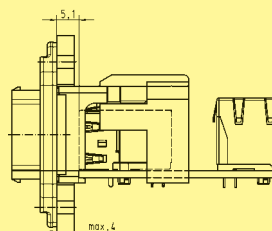

Identification

Part No.

Drawing

Dimensions in mm

Panel feed through including housing and printed board with RJ45 jack and 47° jack vertically mounted in the IP20 range

09 35 224 0331

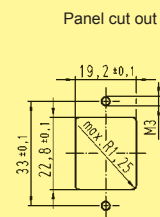
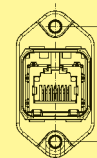
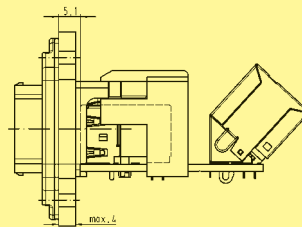

Panel feed through including housing and printed board with RJ45 jack and solder termination in the IP20 range

09 35 226 0331

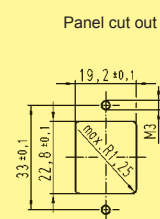
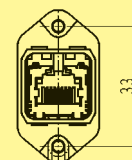
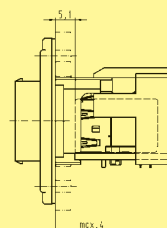

Recommendation for female insert and assembly manual on request.

PushPull



Han® PushPull, type acc. to IEC/PAS 61 076-3-117 variant 14 RJ45 connector

PushPull

Features

- HARTING PushPull technology
- Compact design
- High packing density
- Field-assembly connector with IDC contacts (Cat. 5 versions) or piercing contacts (Cat. 6 versions)

Technical characteristics

Locking	PushPull technology acc. to IEC/PAS 61 076-3-117
Degree of protection	IP 65 / IP 67
Mating face	RJ45 acc. to IEC 60 603-7
Termination cross section for Cat. 5	AWG 24/7 – 22/7 (stranded) AWG 23/1 – 22/1 (solid)
for Cat. 6	AWG 24/7 – 27/7 (stranded)
Mating cycles	min. 750
Temperature range	-40 °C ... +70 °C
Housing material	Plastic, black
Flammability acc. to UL 94	V 0
Cable diameter	5 – 9.5 mm

Identification	Part No.	Drawing	Dimensions in mm
----------------	----------	---------	------------------

Connector set, plastic

incl. housing and male insert

Category 5, 4-poles
HARTING RJ Industrial®

6.5 – 9.5 mm clamp range
PROFINET-Identification:
PROFINET O-Plug RJ45



5 – 8 mm clamp range



Category 6, 8-poles
5 – 8 mm clamp range
Wire manager, white

Wire manager, blue

09 35 221 0421

09 35 222 0421

09 35 223 0421

09 35 224 0421

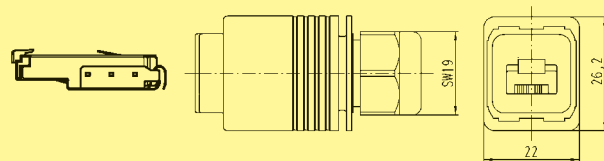

Tools

see page 01.08

Assembled system cables

see catalogue "Ethernet Network Solutions for the Industry B1/48"



Han® PushPull, type acc. to IEC/PAS 61 076-3-117 variant 14
Housing bulkhead mounting for device integration and RJ45 jacks

Features

- HARTING PushPull technology
- Compact design
- High packing density
- Device integration via RJ45 PCB connectors

Technical characteristics

Locking	PushPull technology acc. to IEC/PAS 61 076-3-117
Degree of protection	IP 65 / IP 67
Mating face	RJ45 acc. to IEC 60 603-7
Termination type	Female with solder termination
Mating cycles	min. 750
Temperature range	-40 °C ... +70 °C
Housing material	Zinc die-cast, nickel plated

Identification

Part No.

Drawing

Dimensions in mm

Components device side

Housing bulkhead mounting metal

09 35 002 0301

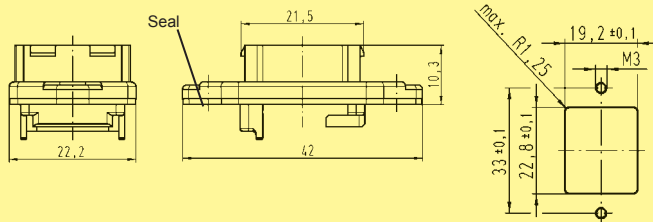

Dust protection cover IP 20 rubber (NBR)

09 35 002 5401

RJ45 female Solder variant, 90° angled

09 35 002 2101

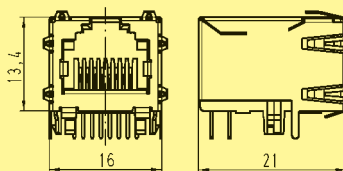

Solder variant, 180° straight

09 35 002 2102

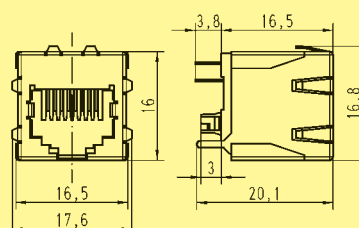

PCB layout

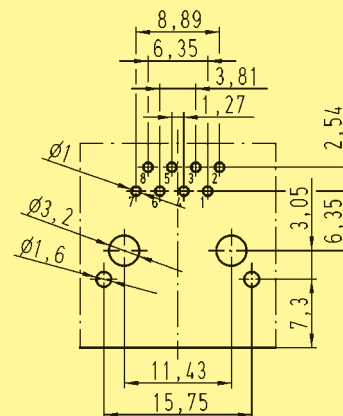



Han® PushPull, type acc. to IEC/PAS 61 076-3-117 variant 14
RJ45 panel feed through

PushPull

Features

- HARTING PushPull technology
- Compact design
- High packing density
- Device integration via RJ45 PCB connectors

Technical characteristics

Locking	PushPull technology acc. to IEC/PAS 61 076-3-117
Degree of protection	IP 65 / IP 67
Mating face	RJ45 acc. to IEC 60 603-7
Termination type	Female with solder termination
Mating cycles	min. 750
Temperature range	-40 °C ... +70 °C
Housing material	Zinc die-cast, nickel plated

Identification

Part No.

Drawing

Dimensions in mm

Han® PushPull RJ45

Panel feed through including housing and printed board with 2 x RJ45 jack horizontally mounted

09 35 221 0311

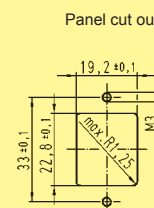
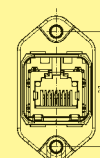
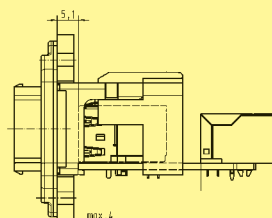

Panel feed through including housing and printed board with RJ45 jack and SEK board

09 35 222 0311

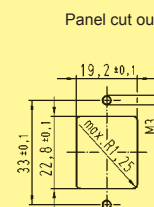
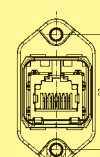
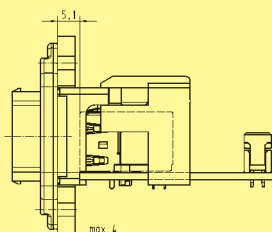

Panel feed through including housing and printed board with RJ45 jack and RJ45 jack vertically mounted in the IP20 range

09 35 223 0311

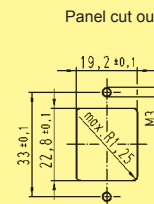
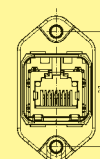
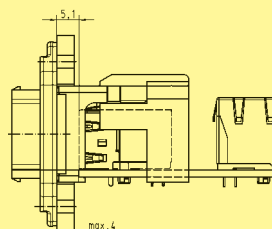

Identification

Part No.

Drawing

Dimensions in mm

Panel feed through including housing and printed board with RJ45 jack and 47° jack vertically mounted in the IP20 range

09 35 224 0311

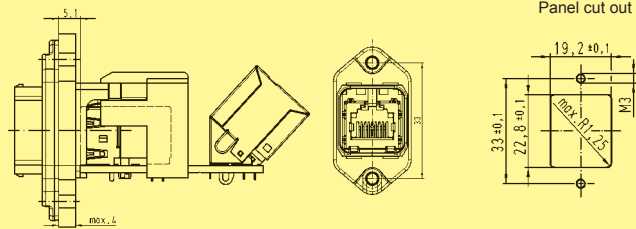

Panel feed through including housing and printed board with RJ45 jack and solder termination in the IP20 range

09 35 226 0311

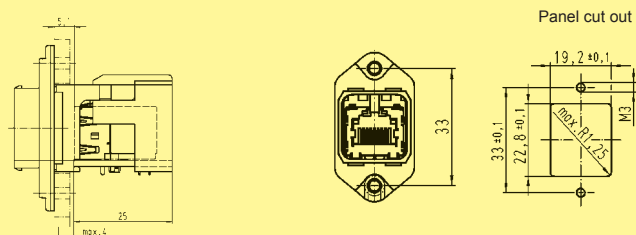

Recommendation for female insert and assembly manual on request.

PushPull



Han® PushPull, type acc. to IEC/PAS 61 076-3-117 variant 14 RJ45 connector

PushPull

Features

- HARTING PushPull technology
- Compact design
- High packing density
- Field-assembly connector with IDC contacts (Cat. 5 versions) or piercing contacts (Cat. 6 versions)

Technical characteristics

Locking	PushPull technology acc. to IEC/PAS 61 076-3-117
Degree of protection	IP 65 / IP 67
Mating face	RJ45 acc. to IEC 60 603-7
Termination cross section for Cat. 5	AWG 24/7 – 22/7 (stranded) AWG 23/1 – 22/1 (solid)
for Cat. 6	AWG 24/7 – 27/7 (stranded)
Mating cycles	min. 750
Temperature range	-40 °C ... +70 °C
Housing material	Zinc die-cast, nickel plated
Cable diameter	5 – 9.5 mm

Identification

Part No.

Drawing

Dimensions in mm

Connector set, metal

incl. housing and male insert

Category 5, 4-poles
HARTING RJ Industrial®
4 – 11 mm clamp range
PROFINET-Identification:
PROFINET O-Plug RJ45



Category 6, 8-poles
4 – 11 mm clamp range
Wire manager, white

Wire manager, blue

09 35 221 0401

09 35 223 0401

09 35 224 0401

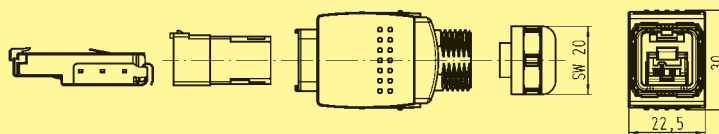

Tools

see page 01.08

Assembled system cables

see catalogue "Ethernet Network Solutions for the Industry B1/48"

Han® PushPull, type acc. to IEC/PAS 61 076-3-117 variant 14 Accessories

Identification	Part No.	Drawing	Dimensions in mm
----------------	----------	---------	------------------

Han® PushPull
dust protection cover
for device side

09 35 002 5401



Han® PushPull
dust protection cover
for cable side

09 35 002 5412



Han® PushPull
protection cover IP 65
for cable side

09 35 002 5411





Han® PushPull, type acc. to IEC/PAS 61 076-3-117 variant 14
 Housing bulkhead mounting for device integration
 Optical connector based on SCRJ

PushPull

Features

- HARTING PushPull technology
- Compact design
- High packing density
- Device integration via transceiver
- Han® PushPull SCRJ for POF is according the requirements of AIDA (German Domestic Automobile Manufacturers)

Technical characteristics

Locking	PushPull technology acc. to IEC/PAS 61 076-3-117
Degree of protection	IP 65 / IP 67
Mating face	SCRJ acc. to IEC 50 377-3-6
Fiber Typen	POF ¹⁾ 1 mm HCS ^{®2)} 200 µm / 230 µm MM 62,5 µm / 125 µm MM 50 µm / 125 µm SM 10 µm / 125 µm
Mating cycles	min. 750
Temperature range	-40 °C ... +70 °C
Housing material	Plastic, black
Flammability acc. to UL 94	V 0

Identification	Part No.	Drawing	Dimensions in mm
----------------	----------	---------	------------------

Components device side

Housing bulkhead mounting
 Optical transceiver not included

plastic

09 35 002 0323

Dust protection cover IP 20
 rubber (NBR)

09 35 002 5401

Reference for transceiver as well as mounting instruction on request

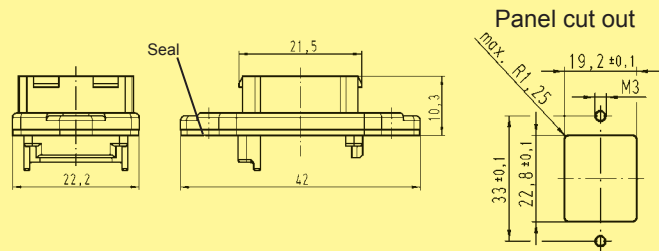

1) POF = Polymer-Optical Fibre
 2) HCS[®] = Hard Clad Silica (registered trademark of SpecTran Corporation)



Han® PushPull, type acc. to IEC/PAS 61 076-3-117 variant 14
 RJ45 panel feed through
 for optical connector based on SCRJ

Features

- HARTING PushPull technology
- Compact design
- High packing density
- Han® PushPull SCRJ for POF is according the requirements of AIDA (German Domestic Automobile Manufacturers)

Technical characteristics

Locking	PushPull technology acc. to IEC/PAS 61 076-3-117
Degree of protection	IP 65 / IP 67
Mating face	SCRJ acc. to IEC 50 377-3-6
Fiber Typen	POF ¹⁾ 1 mm HCS ²⁾ 200 µm / 230 µm MM 62,5 µm / 125 µm MM 50 µm / 125 µm SM 10 µm / 125 µm
Mating cycles	min. 750
Temperature range	-40 °C ... +70 °C
Housing material	Plastic, black
Flammability acc. to UL 94	V 0

Identification

Part No.

Drawing

Dimensions in mm

Han® PushPull SCRJ

Panel feed through

09 35 242 0333

SC contacts order separately

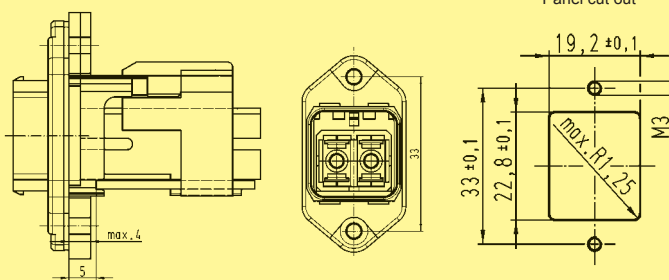

Contacts

SC POF contact, 1 mm	20 10 001 5217
SC 125 GI contact	20 10 125 5211
SC 230 HCS contact	20 10 230 5211



Han® PushPull, type acc. to IEC/PAS 61 076-3-117 variant 14 SCRJ connector

PushPull

Features

- HARTING PushPull technology
- Compact design
- High packing density
- Han® PushPull SCRJ for POF is according the requirements of AIDA (German Domestic Automobile Manufacturers)

Technical characteristics

Locking	PushPull technology acc. to IEC/PAS 61 076-3-117
Degree of protection	IP 65 / IP 67
Mating face	SCRJ acc. to IEC 50 377-3-6
Fiber Typen	POF ¹⁾ 1 mm HCS ^{®2)} 200 µm / 230 µm MM 62,5 µm / 125 µm MM 50 µm / 125 µm SM 10 µm / 125 µm
Mating cycles	min. 750
Temperature range	-40 °C ... +70 °C
Housing material	Plastic, black
Flammability acc. to UL 94	V 0

Identification

Part No.

Drawing

Dimensions in mm

Connector set, plastic

incl. housing and SCRJ insert

PROFINET-Identification:
PROFINET O-Plug SCRJ

SC contacts order separately



09 35 241 0422

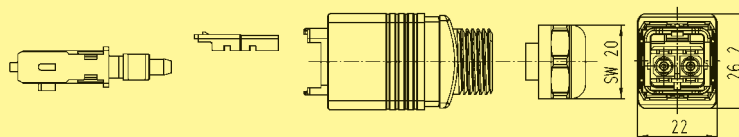

Contacts

SC POF contact, 1 mm
SC 125 GI contact
SC 230 HCS contact

20 10 001 5217
20 10 125 5211
20 10 230 5211



Han® PushPull, type acc. to IEC/PAS 61 076-3-117 variant 14
 Housing bulkhead mounting for device integration
 Optical connector based on SCRJ

Features

- HARTING PushPull technology
- Compact design
- High packing density
- Device integration via transceiver
- Han® PushPull SCRJ for POF is according the requirements of AIDA (German Domestic Automobile Manufacturers)

Technical characteristics

Locking	PushPull technology acc. to IEC/PAS 61 076-3-117
Degree of protection	IP 65 / IP 67
Mating face	SCRJ acc. to IEC 50 377-3-6
Fiber Typen	POF ¹⁾ 1 mm HCS ²⁾ 200 µm / 230 µm MM 62,5 µm / 125 µm MM 50 µm / 125 µm SM 10 µm / 125 µm
Mating cycles	min. 750
Temperature range	-40 °C ... +70 °C
Housing material	Zinc die-cast, nickel plated

Identification

Part No.

Drawing

Dimensions in mm

Components device side

Housing bulkhead mounting
 Optical transceiver
 not included

metal

09 35 002 0303

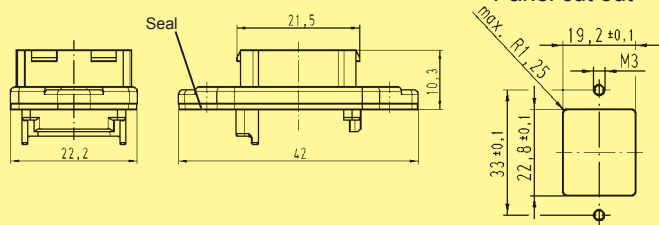

Dust protection cover IP 20
 rubber (NBR)

09 35 002 5401

Reference for transceiver
 as well as mounting instruction
 on request

1) POF = Polymer-Optical Fibre
 2) HCS® = Hard Clad Silica (registered trademark of SpecTran Corporation)



Han® PushPull, type acc. to IEC/PAS 61 076-3-117 variant 14
 RJ45 panel feed through
 for optical connector based on SCRJ

PushPull

Features

- HARTING PushPull technology
- Compact design
- High packing density
- Han® PushPull SCRJ for POF is according the requirements of AIDA (German Domestic Automobile Manufacturers)

Technical characteristics

Locking	PushPull technology acc. to IEC/PAS 61 076-3-117
Degree of protection	IP 65 / IP 67
Mating face	SCRJ acc. to IEC 50 377-3-6
Fiber Typen	POF ¹⁾ 1 mm HCS ^{®2)} 200 µm / 230 µm MM 62,5 µm / 125 µm MM 50 µm / 125 µm SM 10 µm / 125 µm
Mating cycles	min. 750
Temperature range	-40 °C ... +70 °C
Housing material	Zinc die-cast, nickel plated

Identification

Part No.

Drawing

Dimensions in mm

Han® PushPull SCRJ

Panel feed through

09 35 242 0313

SC contacts order separately

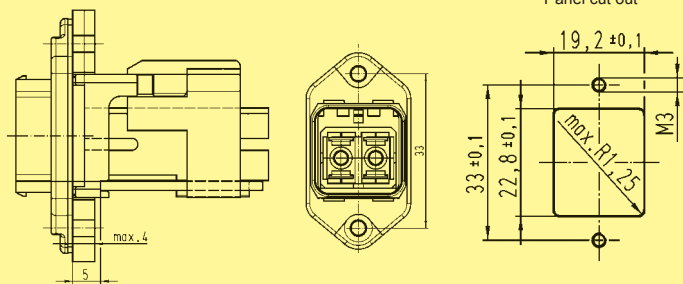

Contacts

- SC POF contact, 1 mm
- SC 125 GI contact
- SC 230 HCS contact

- 20 10 001 5217
- 20 10 125 5211
- 20 10 230 5211



Han® PushPull, type acc. to IEC/PAS 61 076-3-117 variant 14
SCRJ connector

Features

- HARTING PushPull technology
- Compact design
- High packing density
- Han® PushPull SCRJ for POF is according the requirements of AIDA (German Domestic Automobile Manufacturers)

Technical characteristics

Locking	PushPull technology acc. to IEC/PAS 61 076-3-117
Degree of protection	IP 65 / IP 67
Mating face	SCRJ acc. to IEC 50 377-3-6
Fiber Typen	POF ¹⁾ 1 mm HCS ²⁾ 200 µm / 230 µm MM 62,5 µm / 125 µm MM 50 µm / 125 µm SM 10 µm / 125 µm
Mating cycles	min. 750
Temperature range	-40 °C ... +70 °C
Housing material	Zinc die-cast, nickel plated
Flammability acc. to UL 94	V 0

Identification

Part No.

Drawing

Dimensions in mm

Connector set, metal
incl. housing and SCRJ insert

PROFINET-Identification:
PROFINET O-Plug SCRJ

SC contacts order separately

09 35 241 0402

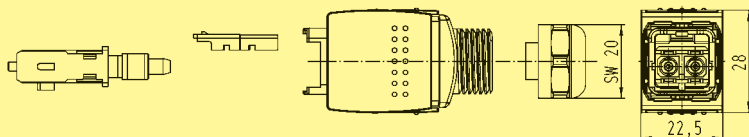

Contacts

SC POF contact, 1 mm
SC 125 GI contact
SC 230 HCS contact

20 10 001 5217
20 10 125 5211
20 10 230 5211



Han® PushPull, type acc. to IEC/PAS 61 076-3-117 variant 14
 Housing bulkhead mounting and power females for device integration

PushPull

Features

- HARTING PushPull technology
- Compact, space-saving design
- Touch-proof
- Device side: male
 - Solder variant, angled

Technical characteristics

Locking	PushPull technology acc. to IEC/PAS 61 076-3-117
Degree of protection	IP 65 / IP 67
Number of contacts	4 + PE
Electrical data acc. to DIN EN 61 984	16 A 230/400 V 4 kV 3
Termination	Male insert with solder termination
Mating cycles	min. 500
Temperature range	-40 °C ... +85 °C
Housing material	Plastic, black
Flammability acc. to UL 94	V 0

Identification	Part No.	Drawing	Dimensions in mm
----------------	----------	---------	------------------

Components device side

Housing bulkhead mounting plastic

09 35 002 0323

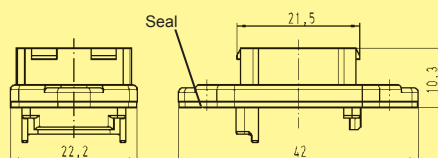

Panel cut out

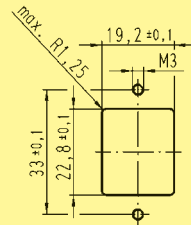

Dust protection cover IP 20, rubber (NBR)

09 35 002 5401

Male insert with solder termination angled

09 35 002 3003

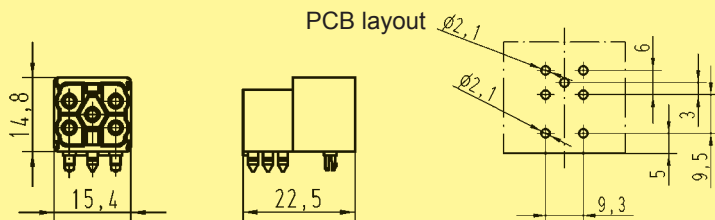

Male insert with solder termination straight

09 35 002 3004

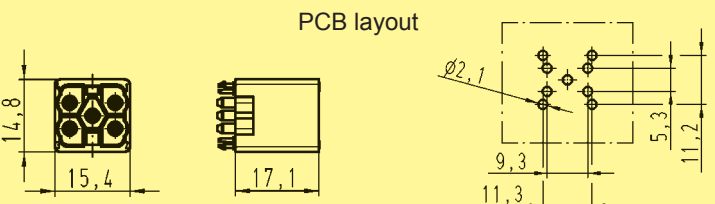



Han® PushPull, type acc. to IEC/PAS 61 076-3-117 variant 14
 Panel feed-through, 5-poles, 230/400 V, 16 A

Features

- HARTING PushPull technology
- Compact, space-saving design
- Touch-proof
- Panel feed-through
 - crimp termination
 - Han-Quick Lock® termination
 - solder termination

Technical characteristics

Locking	PushPull technology acc. to IEC/PAS 61 076-3-117
Degree of protection	IP 65 / IP 67
Number of contacts	4 + PE
Electrical data acc. to DIN EN 61 984	16 A 690 V 4 kV 3
• with solder termination	16 A 230/400 V 4 kV 3
Termination cross section	0,5 – 2,5 mm ²
Mating cycles	min. 500
Temperature range	-40 °C ... +85 °C
Housing material	Plastic, black
Flammability acc. to UL 94	V 0

Identification	Part No.	Drawing	Dimensions in mm
----------------	----------	---------	------------------

Panel feed through including housing and male insert
 16 A 690 V
 with crimp termination
 please order crimp contacts separately

09 35 231 0333

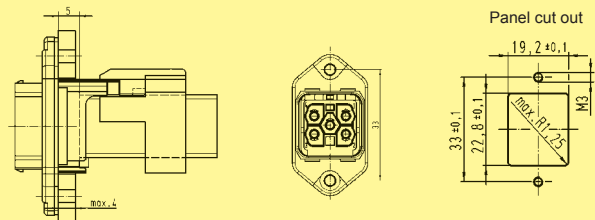

Panel feed through including housing and male insert
 16 A 690 V
 with Han-Quick Lock® termination

09 35 232 0333

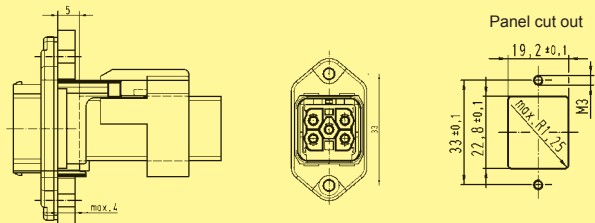

Panel feed through including housing and male insert
 16 A, 230/400 V
 on PCB
 with solder termination

09 35 233 0333

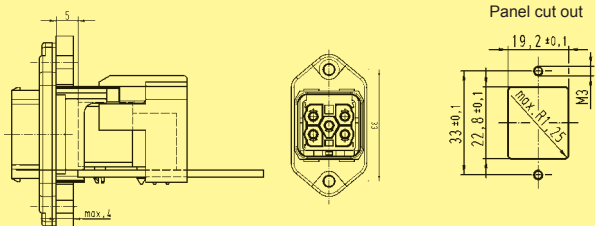



Han® PushPull, type acc. to IEC/PAS 61 076-3-117 variant 14
 Connector, 5-poles, 230/400 V, 16 A

PushPull

Features

- HARTING PushPull technology
- Compact, space-saving design
- Touch-proof
- Cable side: female
 - crimp termination
 - Han-Quick Lock® termination technology
 Field-assembly without special tools

Technical characteristics

Locking	PushPull technology acc. to IEC/PAS 61 076-3-117
Degree of protection	IP 65 / IP 67
Number of contacts	4 + PE
Electrical data acc. to DIN EN 61 984	16 A 690 V 4 kV 3
• with solder termination	16 A 230/400 V 4 kV 3
Termination cross section	0,5 – 2,5 mm ²
Mating cycles	min. 500
Temperature range	-40 °C ... +85 °C
Cable diameter	6.5 – 13 mm
Housing material	Plastic, black
Flammability acc. to UL 94	V 0

Identification	Part No.	Drawing	Dimensions in mm
----------------	----------	---------	------------------

Connector set, plastic

incl. housing and female insert

with crimp termination
 9 – 13 mm clamp range
 Han® P crimp contacts
 order separately

09 35 231 0423

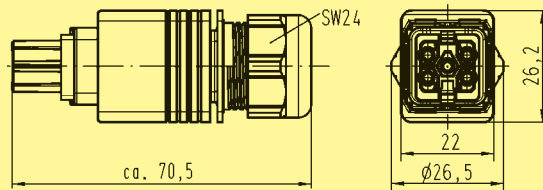

with Han-Quick Lock® termination
 9 – 13 mm clamp range

09 35 232 0423

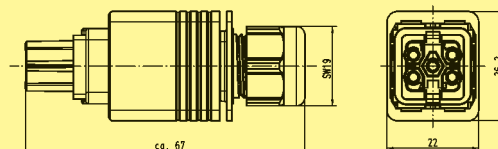
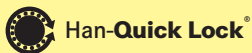

with Han-Quick Lock® termination
 6.5 – 9.5 mm clamp range

09 35 232 0421

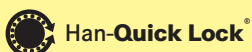



Han® PushPull, type acc. to IEC/PAS 61 076-3-117 variant 14
Housing bulkhead mounting and power females for device integration

Features

- HARTING PushPull technology
- Compact, space-saving design
- Touch-proof
- Device side: male
 - Solder variant, angled

Technical characteristics

Locking	PushPull technology acc. to IEC/PAS 61 076-3-117
Degree of protection	IP 65 / IP 67
Number of contacts	4 + PE
Electrical data acc. to DIN EN 61 984	16 A 230/400 V 4 kV 3
Termination	Male insert with solder termination
Mating cycles	min. 500
Temperature range	-40 °C ... +85 °C
Flammability acc. to UL 94	V 0
Housing material	Zinc die-cast, nickel plated Plastic, black (female)

Identification

Part No.

Drawing

Dimensions in mm

Components device side

Housing bulkhead mounting metal

09 35 002 0303

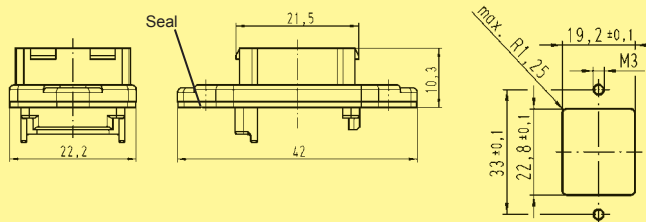

Dust protection cover IP 20, rubber (NBR)

09 35 002 5401

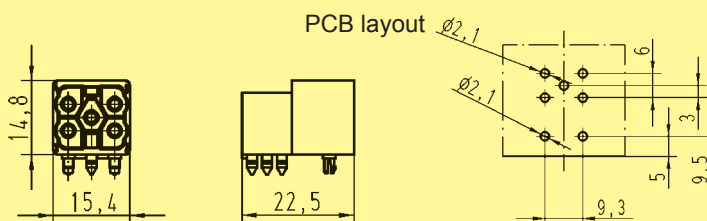

Male insert with solder termination angled

09 35 002 3003

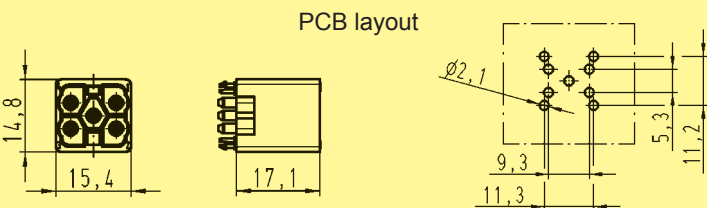

Male insert with solder termination straight

09 35 002 3004

PushPull



Han® PushPull, type acc. to IEC/PAS 61 076-3-117 variant 14
 Panel feed-through, 5-poles, 16 A

PushPull

Features

- HARTING PushPull technology
- Compact, space-saving design
- Touch-proof
- Panel feed-through
 - crimp termination
 - Han-Quick Lock® termination
 - solder termination

Technical characteristics

Locking	PushPull technology acc. to IEC/PAS 61 076-3-117
Degree of protection	IP 65 / IP 67
Number of contacts	4 + PE
Electrical data acc. to DIN EN 61 984	16 A 690 V 4 kV 3
• with solder termination	16 A 230/400 V 4 kV 3
Termination cross section	0,5 – 2,5 mm ²
Mating cycles	min. 500
Temperature range	-40 °C ... +85 °C
Housing material	Zinc die-cast, nickel plated

Identification	Part No.	Drawing	Dimensions in mm
----------------	----------	---------	------------------

Panel feed through including housing and male insert
 16 A, 690 V
 with crimp termination
 please order crimp contacts separately

09 35 231 0313

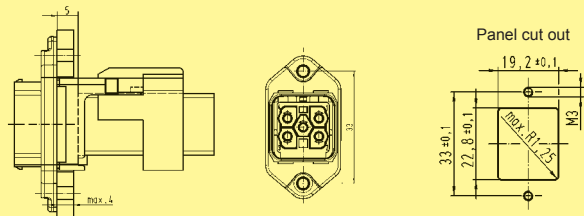

Panel feed through including hood and male insert
 16 A, 690 V
 with Han-Quick Lock® termination

09 35 232 0313

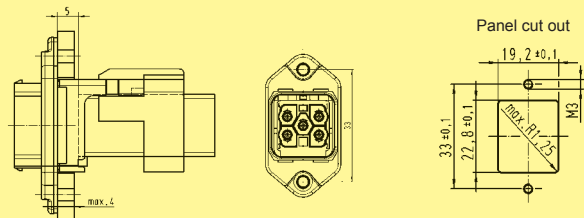

Panel feed through including hood and male insert
 16 A, 230/400 V
 on PCB with solder termination

09 35 233 0313

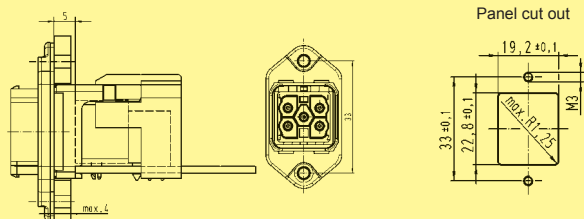



Han® PushPull, type acc. to IEC/PAS 61 076-3-117 variant 14
Connector, 5-poles, 16 A

Features

- HARTING PushPull technology
- Compact, space-saving design
- Touch-proof
- Cable side: female
 - crimp termination
 - Han-Quick Lock® termination technology
 Field-assembly without special tools

Technical characteristics

Locking	PushPull technology acc. to IEC/PAS 61 076-3-117
Degree of protection	IP 65 / IP 67
Number of contacts	4 + PE
Electrical data acc. to DIN EN 61 984	16 A 690 V 4 kV 3
Termination cross section	0,5 – 2,5 mm ²
Mating cycles	min. 500
Temperature range	-40 °C ... +85 °C
Housing material	Zinc die-cast, nickel plated
Cable diameter	4 – 11 mm

Identification	Part No.	Drawing	Dimensions in mm
----------------	----------	---------	------------------

Connector set, metal

incl. housing and female insert

with crimp termination
4 – 11 mm clamp range
Han® P crimp contacts
order separately

09 35 231 0401

with Han-Quick Lock® termination
4 – 11 mm clamp range

09 35 232 0401

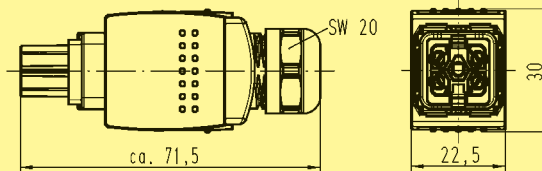
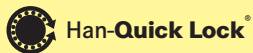

PushPull

Han® PushPull, type acc. to IEC/PAS 61 076-3-117 variant 14 Accessories

PushPull

Identification Part No. Drawing Dimensions in mm

BUCHANAN-
crimping tool

09 99 000 0001



Locator Han P®
for crimping tool 09 99 000 0001

09 99 000 0329

Multiple crimping tool depth
adjustment gauge

09 99 000 0379

Wire gauge
0.5 - 1 mm² ø 1.55
1.5 - 2.5 mm² ø 1.80

Removal tool Han P®

09 99 000 0319



Identification Part number Drawing Dimensions in mm
Male contact Female contact

Crimp contacts Han® P
silver plated

for 0.5 mm ²	09 35 000 6103	09 35 000 6203
for 0.75 mm ²	09 35 000 6104	09 35 000 6204
for 1.0 mm ²	09 35 000 6105	09 35 000 6205
for 1.5 mm ²	09 35 000 6106	09 35 000 6206
for 2.5 mm ²	09 35 000 6107	09 35 000 6207

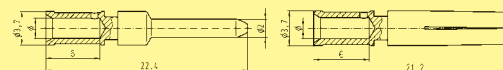

Wire gauge		Ø	Stripping length
for 0.5 mm ²	AWG 20	1.15 mm	6 mm
for 0.75 mm ²	AWG 18	1.30 mm	6 mm
for 1.0 mm ²	AWG 18	1.45 mm	6 mm
for 1.5 mm ²	AWG 16	1.75 mm	6 mm
for 2.5 mm ²	AWG 14	2.25 mm	6 mm



Housing bulkhead mounting and power females for device integration

Features

- HARTING PushPull technology
- Touch-proof
- Device side: male
 - Solder variant, angled and straight
- AIDA-conform (German Domestic Automobile Manufactures)

Technical characteristics

Locking	PushPull technology acc. to IEC/PAS 61 076-3-117
Degree of protection	IP 65 / IP 67
Number of contacts	4 + PE
Electrical data acc. to DIN EN 61 984	16 A 24 V 4 kV 3
Termination	Male insert with solder termination
Mating cycles	min. 500
Temperature range	-40 °C ... +70 °C
Housing material	Plastic, black
Flammability acc. to UL 94	V 0

Identification

Part No.

Drawing

Dimensions in mm

Components device side

Housing bulkhead mounting plastic

09 35 004 0321

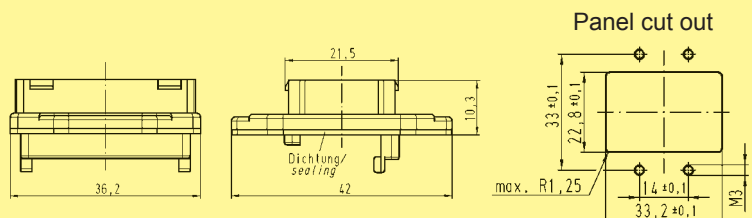

Male insert with solder termination angled

09 35 004 3003

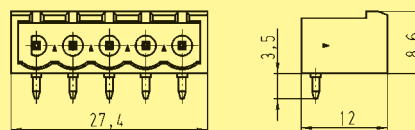

Male insert with solder termination straight

09 35 004 3004

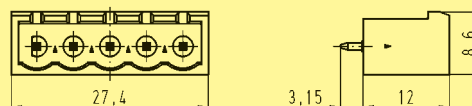

Set components device side, plastic

incl. housing and male insert with solder termination angled

09 35 431 0321

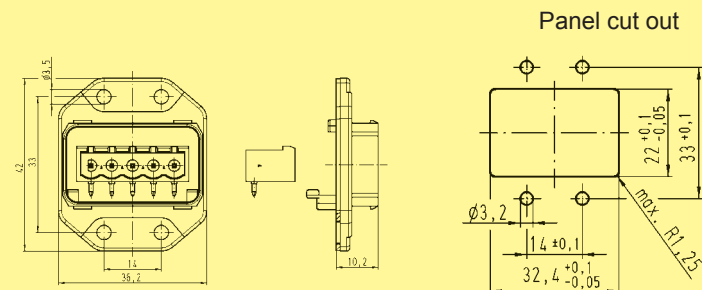



Connector, 5-poles, 24 V, 16 A

PushPull

Features

- HARTING PushPull technology
- Touch-proof
- Cable side: female
- spring force connection
- AIDA-conform
(German Domestic Automobile Manufactures)

Technical characteristics

Locking	PushPull technology acc. to IEC/PAS 61 076-3-117
Degree of protection	IP 65 / IP 67
Number of contacts	4 + PE
Electrical data acc. to DIN EN 61 984	16 A 24 V 4 kV 3
Termination	Spring force connection
Termination cross section	0.75 ... 2.5 mm ²
Mating cycles	min. 500
Temperature range	-40 °C ... +70 °C
Cable diameter	9 – 13 mm
Housing material	Plastic, black
Flammability acc. to UL 94	V 0

Identification

Part No.

Drawing

Dimensions in mm

Connector set, plastic

incl. housing and female insert with spring force connection



09 35 431 0421

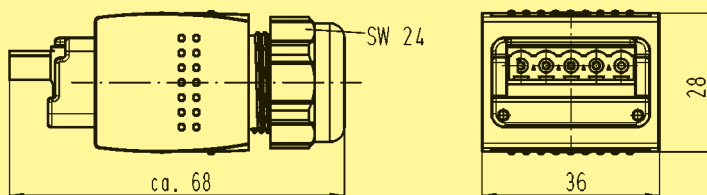



Housing bulkhead mounting and power females for device integration

Features

- HARTING PushPull technology
- Touch-proof
- Device side: male
 - Solder variant, angled and straight
- AIDA-conform (German Domestic Automobile Manufactures)

Technical characteristics

Locking	PushPull technology acc. to IEC/PAS 61 076-3-117
Degree of protection	IP 65 / IP 67
Number of contacts	4 + PE
Electrical data acc. to DIN EN 61 984	16 A 24 V 4 kV
Termination	Male insert with solder termination
Mating cycles	min. 500
Temperature range	-40 °C ... +70 °C
Housing material	Zinc die-cast, nickel plated Plastic, black (female)

Identification

Part No.

Drawing

Dimensions in mm

Components device side

Housing bulkhead mounting metal

09 35 004 0301

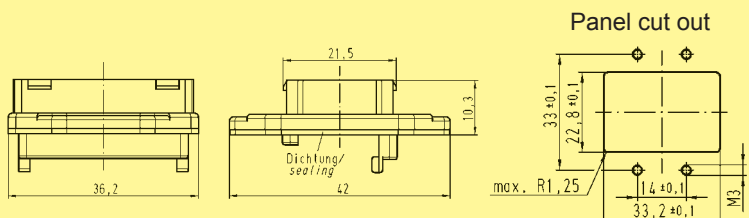

Male insert with solder termination angled

09 35 004 3003

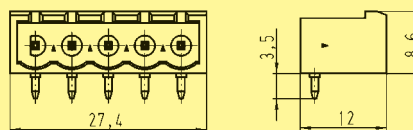

Male insert with solder termination straight

09 35 004 3004

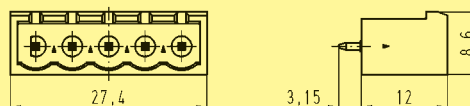

Set components device side, metal

incl. housing and male insert with solder termination angled

09 35 431 0301

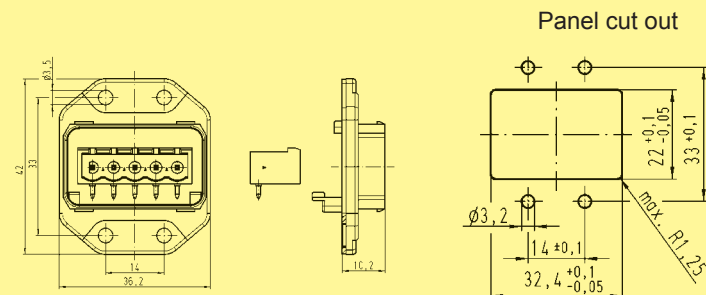



Connector, 5-poles, 24 V, 16 A

PushPull

Features

- HARTING PushPull technology
- Touch-proof
- Cable side: female
- spring force connection
- AIDA-conform
(German Domestic Automobile Manufactures)

Technical characteristics

Locking	PushPull technology acc. to IEC/PAS 61 076-3-117
Degree of protection	IP 65 / IP 67
Number of contacts	4 + PE
Electrical data acc. to DIN EN 61 984	16 A 24 V 4 kV 3
Termination	Spring force connection
Termination cross section	0.75 ... 2.5 mm ²
Mating cycles	min. 500
Temperature range	-40 °C ... +70 °C
Cable diameter	9 – 13 mm
Housing material	Zinc die-cast, nickel plated

Identification

Part No.

Drawing

Dimensions in mm

Connector set, metal

incl. housing and female insert with spring force connection



09 35 431 0401

